



KeysFitness[®]

KF-DB3

DUMBBELL RACK 3FT

Owner's Manual

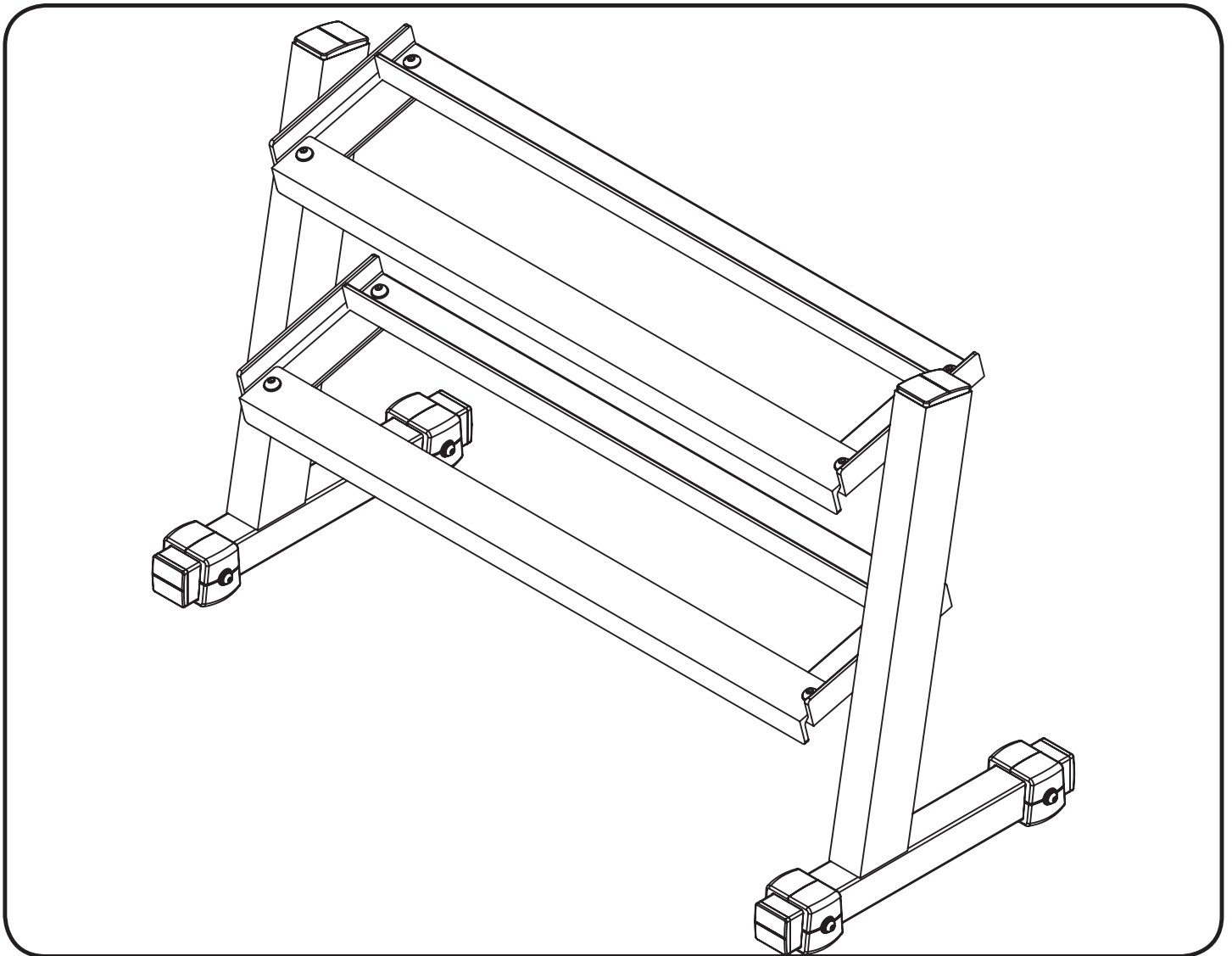

! CAUTION

Read all precautions and instructions in this manual before using this equipment.

215-00118
10/06 Rev A

Important Safety Information	3
Before You Start	4
Assembly/Exploded View	5-6
Parts List	7
Warranty Information	8

Important Safety Information



THANK YOU for making this unit a part of your exercise program. Keys Fitness assures the very best in value, appearance, durability and biomechanics.

This manual will guide you through the assembly process. If at any time you are having trouble with the assembly or use of this product, then please contact us at our Keys Fitness Help line. We have trained service technicians on site to take care of you, our valued customer.

REGISTRATION CARD

To avoid unnecessary delays in warranty parts and to insure that a permanent record of your purchase is on file with our company, be sure to send in the warranty registration card or register on-line at www.keysfitness.com within 10 days of purchase.

KEYS FITNESS SERIES

MODEL: KF-DB3

QUESTIONS?

CALL

1-888-340-0482

Monday-Friday

8:30-5:30 Central Time

When calling please have the following product information available:

Model Name :

Date Mfg.:

PO # :

Serial #

Model Name Decal Location

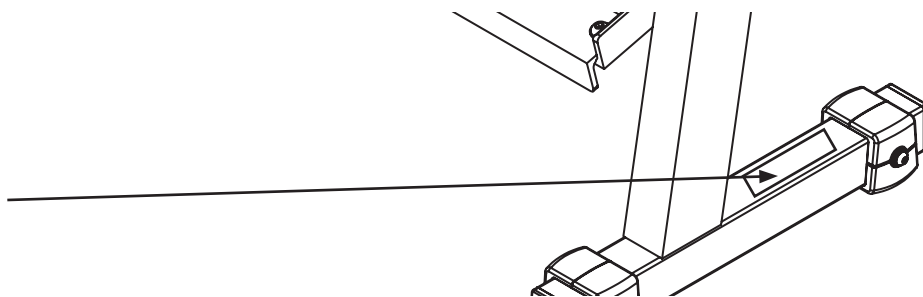

NOTE: Hand tighten bolts and nylon nuts until machine is fully assembled.

Prior to assembly, remove components from the box and verify that all the listed parts were supplied.

SAFETY INFORMATION WARNING!

Before using this unit or starting any exercise program, consult your physician. This is especially important for persons over the age of 35 and/or persons with pre-existing health problems. Keys Fitness Products LP assumes no responsibility for personal injury or property damage sustained by or through the use of this product.

It is the owner's responsibility to ensure that all users of this unit have read the Owner's Manual and are familiar with safety information and precautions.

SAFETY PRECAUTIONS

- This unit should only be used on a level surface and is intended for indoor use only. Keys Fitness recommends an equipment mat be placed under the unit to protect the floor or carpet and for easier cleaning.
- Wear comfortable, good-quality walking or running shoes and appropriate clothing. Do not use this unit with bare feet, sandals, socks or stockings!
- Always examine your unit before using to ensure all parts are in working order.
- Do not leave children unsupervised near or on the unit.
- Service to your unit should only be performed by an authorized service representative, unless authorized and/or instructed by a Keys Fitness technician. Failure to follow these instructions will void the warranty.

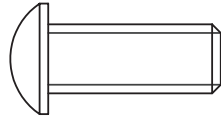

[6#] M10*25 8pcs

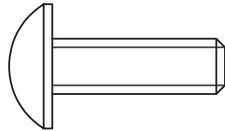

[12#] M8*25 8pcs

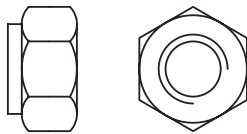

[7#] M10 8pcs

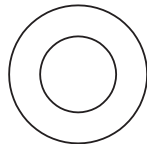

[8#] $\phi 11 * \phi 20 * 2$ 16pcs

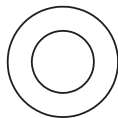

[13#] $\phi 9 * \phi 16 * 1.6$ 8pcs

Exploded View/Assembly

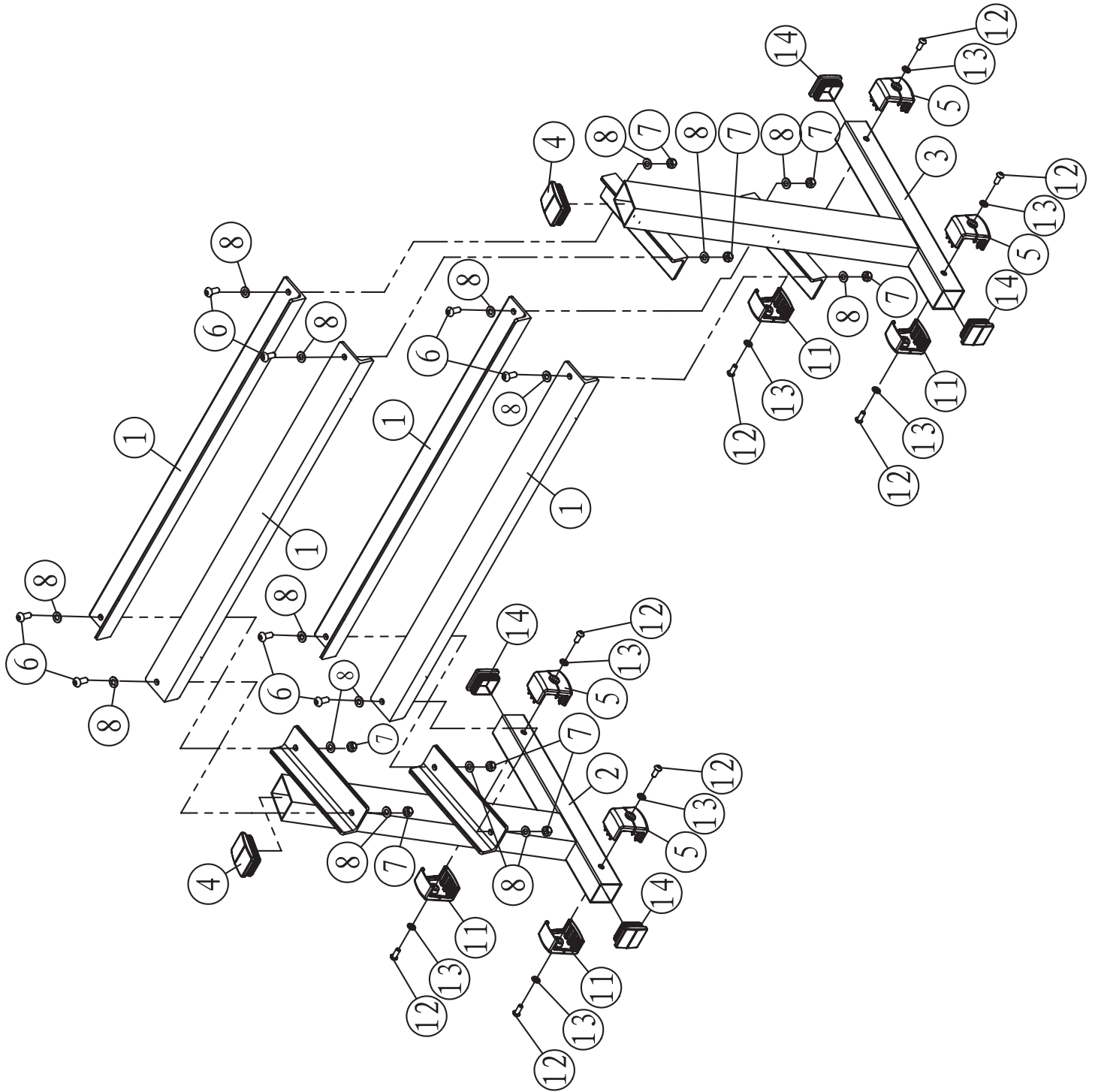

KF-DB3 Parts List Rev A

Ref #	Part #	Description	Qty
1	223-00067	RAIL KPS-DB3	4
2	223-00963	UPRIGHT, LEFT FRAME KF-DB3	1
3	223-00964	UPRIGHT, RIGHT FRAME KF-DB3	1
4	206-00394	PLUG, 50.8X76.2 KF SERIES	2
5	206-00392	FOOT CAP, RIGHT 50.8 KF SERIES	4
6	202-00087	ALLEN BOLT, M10*25	8
7	202-00097	M10 SILVER WASHER	8
8	202-00093	WASHER, 10	16
11	206-00393	FOOT CAP, LEFT 50.8 KF SERIES	4
12	202-00659	SCREW, BUTTON HEAD SOCKET CAP M8X25	8
13	202-00094	WASHER 8, 9*28*2	8
14	206-00391	SQUARE PLUG, 50.8 KF SERIES	4
#	202-00683	BOLT PACK, KF-DB3	1

KEYS FITNESS PRODUCTS, L.P. LIFETIME WARRANTY



This Warranty applies in the United States and Canada to products manufactured or distributed by Keys Fitness Products, LP (“Keys”) under the KEYS brand name. The warranty is non-transferable and valid only to the original purchaser.

Keys warrants that the Product you have purchased for non-commercial, personal, family, or household use from Keys or from an authorized Keys reseller is free from defects in materials or workmanship under normal use during the warranty period. Your sales receipt, showing the date of purchase of the Product, is your proof of purchase. This warranty only extends to you, the original purchaser. It is not transferable to anyone who subsequently purchases or acquires the Product from you. This Warranty becomes VALID ONLY if the product is purchased through a Keys Fitness authorized dealer unless otherwise authorized by Keys Fitness in writing and must be assembled / installed according to the instructions included with the Product.

In a light institutional setting, Keys will extend a one year limited warranty to the original purchaser.

During the warranty period Keys will repair or replace (at Keys' option) the product if it becomes defective, malfunctions, or otherwise fails to conform with this Warranty under normal use. In repairing the Product, Keys may replace defective parts with new or, at the option of Keys, serviceable used parts that are equivalent to new parts in performance. All exchanged parts and Products replaced under this warranty will become the property of Keys. Keys reserves the right to change manufacturers of any part to cover any existing warranty.

This warranty DOES NOT COVER shipping charges, export taxes, custom duties and taxes, or any other charges associated with transportation of the parts or Product. To obtain warranty service, you must contact a Keys authorized retailer, service technician or Keys Fitness at our phone number located in this manual. Any parts determined to be defective must be returned to Keys to obtain warranty service. You must prepay any shipping charges, export taxes, custom duties and taxes, or any other charges associated with transportation of the parts or Product. In addition, you are responsible for insuring any parts or Product shipped or returned. You assume the risk of loss during shipment. You must present Keys with proof-of-purchase documents (including the date of purchase). Any evidence of alteration, erasure or forgery of proof-of-purchase documents will be cause to void this Warranty.

This Warranty does not extend to any product not purchased from Keys or from an authorized Keys reseller. This Limited Warranty does not extend to any Product that has been damaged or rendered defective; (a) as a result of accident, misuse, or abuse; (b) by the use of parts not manufactured or sold by Keys; (c) by modification of the Product; (d) operation on incorrect power supplies; or (e) as a result of service by anyone other than Keys, or an authorized Keys warranty service provider. Product on which the serial number has been defaced or removed is not eligible for warranty service. Should any Product submitted for warranty service be found ineligible, an estimate of repair cost will be furnished and the repair will be made if requested by you upon Keys' receipt of payment or acceptable arrangements for payment.

EXCEPT AS EXPRESSLY SET FORTH IN THIS WARRANTY, KEYS MAKES NO OTHER WARRANTIES, EXPRESSED OR IMPLIED, INCLUDING ANY IMPLIED WARRANTIES OF MERCHANTABILITY AND FITNESS FOR A PARTICULAR PURPOSE. KEYS EXPRESSLY DISCLAIMS ALL WARRANTIES NOT STATED IN THIS LIMITED WARRANTY. ANY IMPLIED WARRANTIES THAT MAY BE IMPOSED BY LAW ARE LIMITED TO THE TERMS OF THIS LIMITED WARRANTY. NEITHER KEYS NOR ANY OF ITS AFFILIATES SHALL BE RESPONSIBLE FOR INCIDENTAL OR CONSEQUENTIAL DAMAGES. SOME STATES DO NOT ALLOW LIMITATIONS ON HOW LONG AN IMPLIED WARRANTY LASTS OR THE EXCLUSION OR LIMITATION OF INCIDENTAL OR CONSEQUENTIAL DAMAGES, SO THE ABOVE LIMITATIONS OR EXCLUSION MAY NOT APPLY TO YOU. This Limited Warranty gives you specific legal rights and you may also have other rights that may vary from state to state. This is the only express warranty applicable to Keys-branded products. Keys neither assumes nor authorizes anyone to assume for it any other express warranty.

PLEASE SEND IN THE INCLUDED WARRANTY CARD OR REGISTER ON-LINE AT www.keysfitness.com WITHIN TEN (10) DAYS OF PURCHASE TO REGISTER YOUR UNIT WITH KEYS FITNESS PRODUCTS, LP. MAIL WARRANTY CARD TO: KEYS FITNESS PRODUCTS, PO BOX 551239, DALLAS, TX 75355



Keys Fitness Products, L.P.
4009 Distribution Drive, Suite 250
Garland, Texas 75041
Customer Service: 1-888-340-0482